

## Fingerprint click™

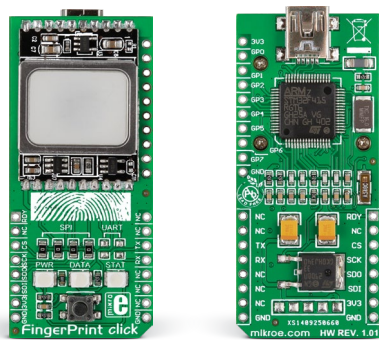

### 1. Introduction

Fingerprint click™ is a click board solution for adding biometric security to your design. It carries the **GTS-511E2** module, which is the thinnest optical touch fingerprint sensor in the world. The module comprises a **CMOS** image sensor with a special lens and covering that records real fingerprints while resists 2D fakes. The click™ board also carries an **STM32 MCU** for processing the images and forwarding them to an external MCU or PC.

### 2. Soldering the headers

Before using your click™ board, make sure to solder 1x8 male headers to both left and right side of the board. Two 1x8 male headers are included with the board in the package.

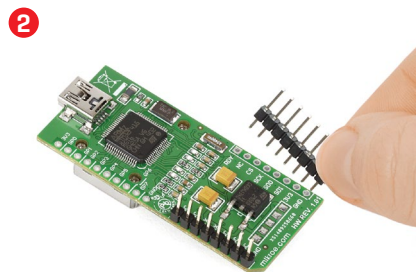
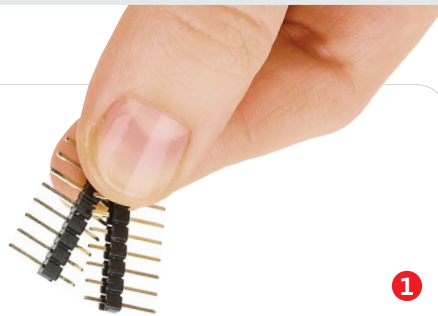

Turn the board upside down so that the bottom side is facing you upwards. Place shorter pins of the header into the appropriate soldering pads.

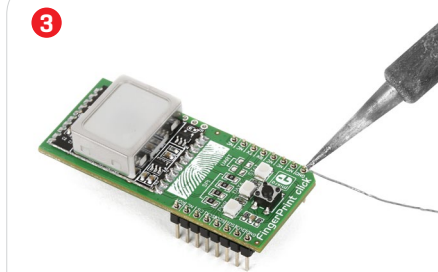

Turn the board upward again. Make sure to align the headers so that they are perpendicular to the board, then solder the pins carefully.

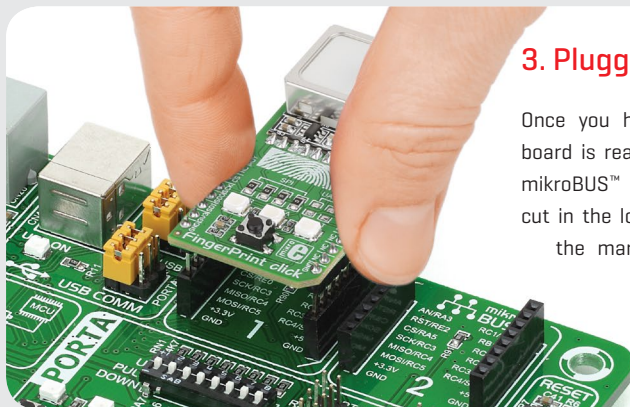

### 3. Plugging the board in

Once you have soldered the headers your board is ready to be placed into the desired mikroBUS™ socket. Make sure to align the cut in the lower-right part of the board with the markings on the silkscreen at the mikroBUS™ socket. If all the pins are aligned correctly, push the board all the way into the socket.

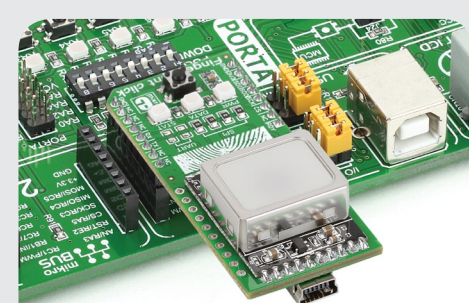

### 4. Essential features

Fingerprint click™ can communicate with the target board MCU through **UART (TX, RX)** or **SPI (CS, SCK, MISO, MOSI)** lines. However it also carries a mini USB connector for connecting the click™ board to a PC — which will generally be a more suitable platform for developing fingerprint recognition software, due to the processing powers required for comparing and matching inputs to a large database of existing images. The board is also lined with additional GPIO pins giving more access to the onboard STM32. Fingerprint click™ is designed to use a 3.3V power supply.

**click™**  
**BOARD**  
[www.mikroe.com](http://www.mikroe.com)



FINGERPRINT click™ manual  
ver 1.01



## 5. Schematic

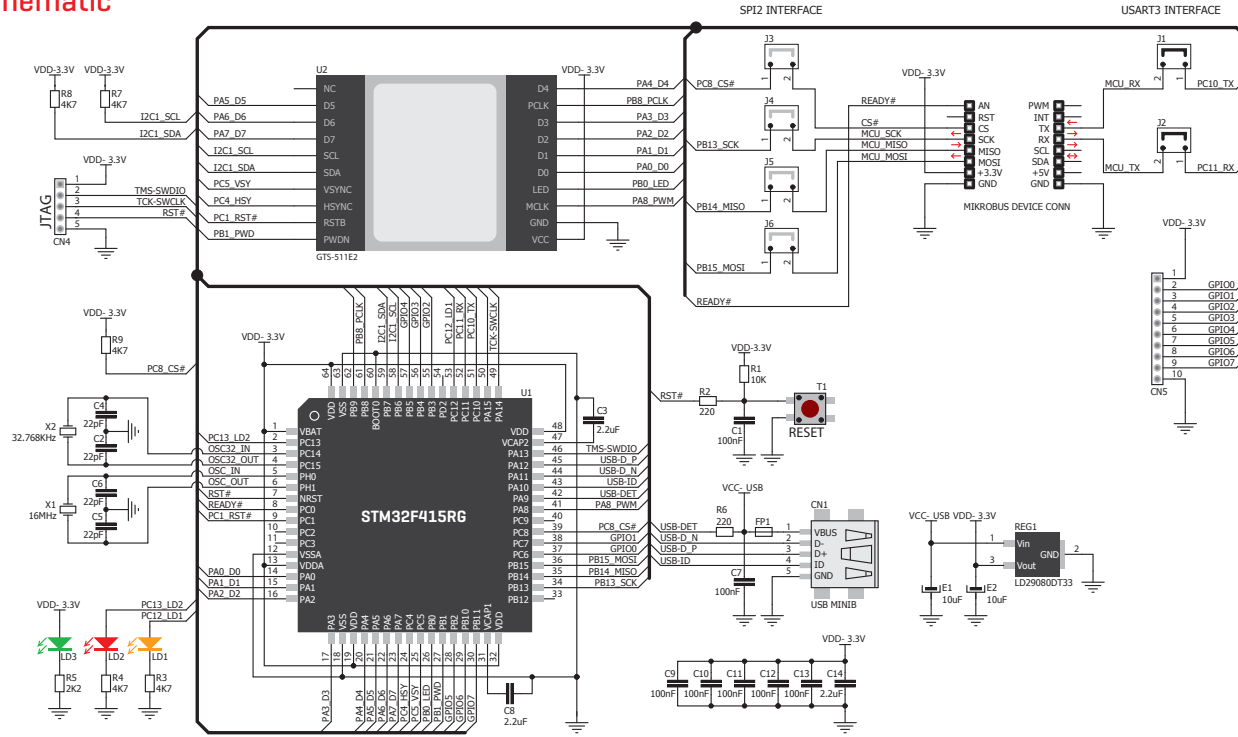

## 6. Dimensions

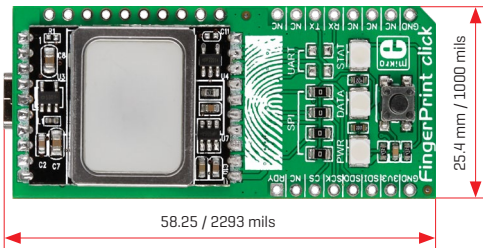

	mm	mils
LENGTH	58.25	2293
WIDTH	25.4	1000
HEIGHT*	14.14	557

\* without headers

## 7. Windows app

We created a Windows application that provides an **easy interface** for communicating with FingerPrint click™. The code is available on Libstock so you can use it as a starting point for developing more sophisticated software. Alternatively, the DLL files that control the onboard module are also available, so you can develop your own app from scratch.

## 8. Code examples

Once you have done all the necessary preparations, it's time to get your click™ board up and running. We have provided examples for mikroC™, mikroBasic™ and mikroPascal™ compilers on our **Libstock** website. Just download them and you are ready to start.



## 9. Support

MikroElektronika offers **free tech support** ([www.mikroe.com/support](http://www.mikroe.com/support)) until the end of the product's lifetime, so if something goes wrong, we're ready and willing to help!



## 10. Disclaimer

MikroElektronika assumes no responsibility or liability for any errors or inaccuracies that may appear in the present document. Specification and information contained in the present schematic are subject to change at any time without notice.

Copyright © 2015 MikroElektronika.  
All rights reserved.

# Mouser Electronics

Authorized Distributor

Click to View Pricing, Inventory, Delivery & Lifecycle Information:

[MikroElektronika:](#)

[MIKROE-1722](#)